

Vibrant Colors and Powerful Performance Bring Content to Life

98/86/75UH5E

With superb picture quality and cutting-edge intelligence, the UH5E series enlivens colors without the aid of peripherals. Its quality and brightness are enough to capture the attention of passersby. Moreover, its convenient advanced usability allows users to effortlessly control and manage the display.



Vibrant Colors and Powerful Performance Bring Content to Life

98/86/75UH5E

Superior Picture Quality

True Color, Immersive View

The UH5E series is large enough to display content and get undivided attention from various viewers. LG IPS panel features a wide range of angle to deliver clear content regardless of the position of viewers. Each pixel in the IPS panel reproduces image colors true-to-life, without distortion.

Vivid Color Details with Ultra HD

The UHD resolution allows users to view details even when zooming in on the display, with four times higher definition than FHD. The UH5E ensures stable UHD video playback with HEVC (High Efficiency Video Coding).

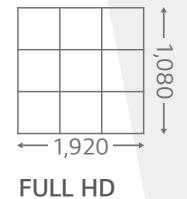
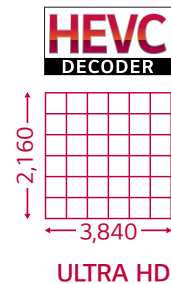

Vibrant Colors and Powerful Performance Bring Content to Life

98/86/75UH5E

Powerful webOS Smart Signage Platform

Easy Content Management

The embedded CMS (Content Management System) allows you to create and edit content using internal/external sources as well as set playlists to play at the desired schedule without the need for a separate PC. Thanks to the intuitive GUI and a menu structure based on usage scenarios, content management has been made much easier.



Simple Group Management

The embedded Group Manager makes a master display work as a server and manage other displays* connected on the same network. This way you can group and control multiple displays in your place of business and distribute playlists to them all at once, using input devices such as a remote control.

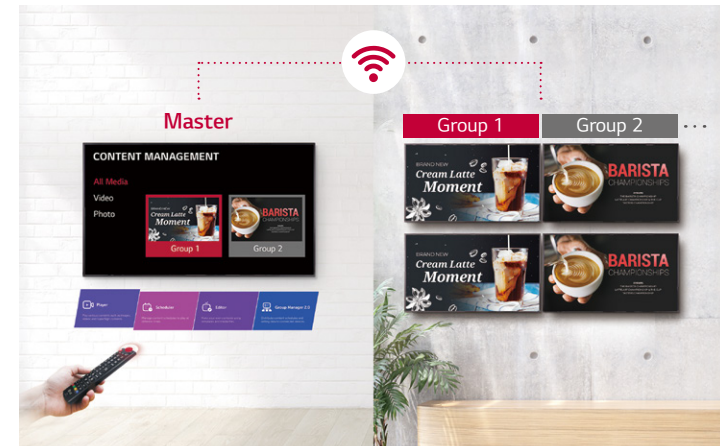

* One master display can create a max. of 25 groups, and each group can consist of a max. of 12 slave displays.

Vibrant Colors and Powerful Performance Bring Content to Life

98/86/75UH5E

Powerful webOS Smart Signage Platform

Various Sensor Applications

LG webOS smart signage platform easily supports connections with external sensors such as GPIO, NFC/RFID, temperature sensors, etc. via USB plug-in. The overall cost of ownership is reduced as there's no need to purchase additional software or media players for creating value-added solutions.

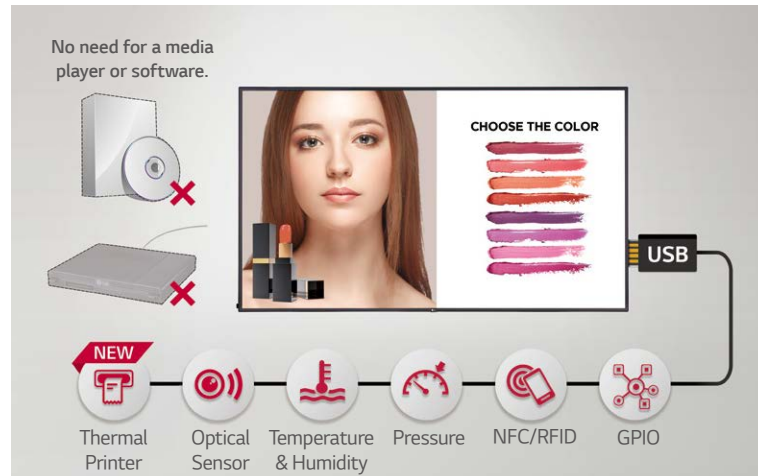

Multi Screen Mode

PBP (Picture-By-Picture) features multi screen in a single display with upto 4 input sources while PIP (Picture-In-Picture) supports playing both main screen and sub screen at the same time with various layouts. This gives great flexibility to allocate space for each content source.

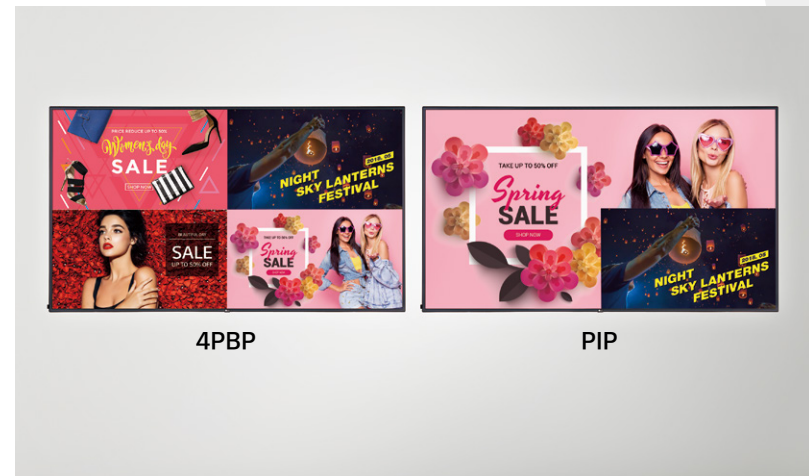

Vibrant Colors and Powerful Performance Bring Content to Life

98/86/75UH5E

Easy Maintenance

Real-Time Monitoring & Control

Through the Control Manager, the embedded web monitoring solution, you can control and monitor the status of multiple displays in different locations in real-time. It is available on internet-connected devices, allowing you to flexibly and rapidly respond to emergency situations anywhere.

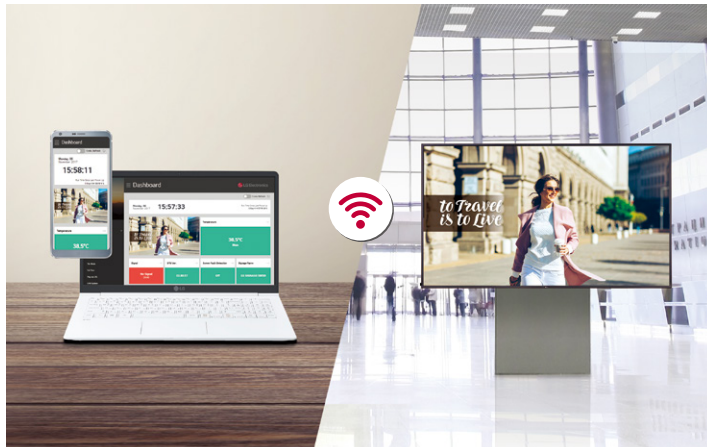

Real-time Care Service

The maintenance gets easier and faster with an optional service Signage 365 Care*, a cloud service solution provided by LG service. It remotely manages status of displays in client workplaces for fault diagnosis and remote-control services, ensuring the stable operation of a client's business.



* The availability of "Signage 365 Care" service can differ by region, so please contact the LG sales representative in your region for further details.

Vibrant Colors and Powerful Performance Bring Content to Life

98/86/75UH5E

Wireless Solution

Content Sharing

Content Mirroring among devices is more convenient on a Wi-Fi network.

Real-time Promotion

With Beacon and BLE (Bluetooth Low Energy), shop managers can provide coupons and information in real-time.

Wireless Access Point

The UH5E series operates as a virtual router which can be an wireless access point for mobile devices.



Vibrant Colors and Powerful Performance Bring Content to Life

98/86/75UH5E

High Compatibility

Compatibility with AV Control System

The UH5E series has been certified Crestron Connected® for a higher level of compatibility with professional AV controls to achieve seamless integration and automated control*, boosting business management efficiency.



* Network-based control

Compatibility with Video Conference System

For the optimum visual meeting, the UH5E has certified its compatibility with Cisco Spark Room Kits, a system that offers powerful and integrated control* for a smarter video conference, eliminating a waste of time to set up the picture quality or to change input on incoming calls.



* The integrated control of the display and Cisco system is enabled through the HDMI cable connection.

Vibrant Colors and Powerful Performance Bring Content to Life

98/86/75UH5E

Space-efficient Design

Slim and Tidy in Appearance

Although UH5E series is a large-sized display, the product still has a slim depth, a feature that allows easy installation by using less space. An immersive view is attained while maintaining a sleek look.

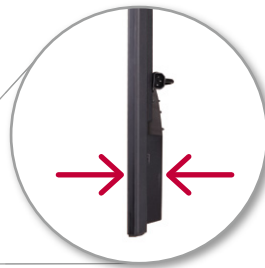

57.9 mm (75")

Detachable Logo & Built-in Speaker

The detachable logo allows for installation in the desired orientation in landscape or portrait mode, making it easy for the user to arrange the signage. Also, sounds can be played from built-in speakers*, giving advertisements greater impact.

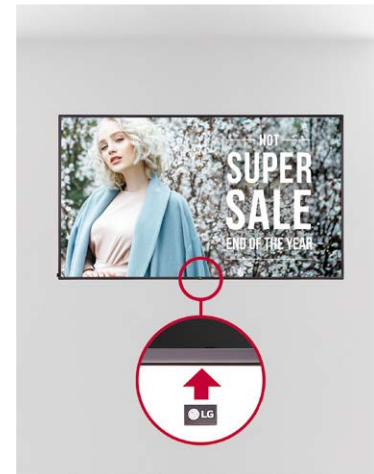

Detachable Logo



Built-in Speaker

* Except 98"

Dimension (unit: mm)

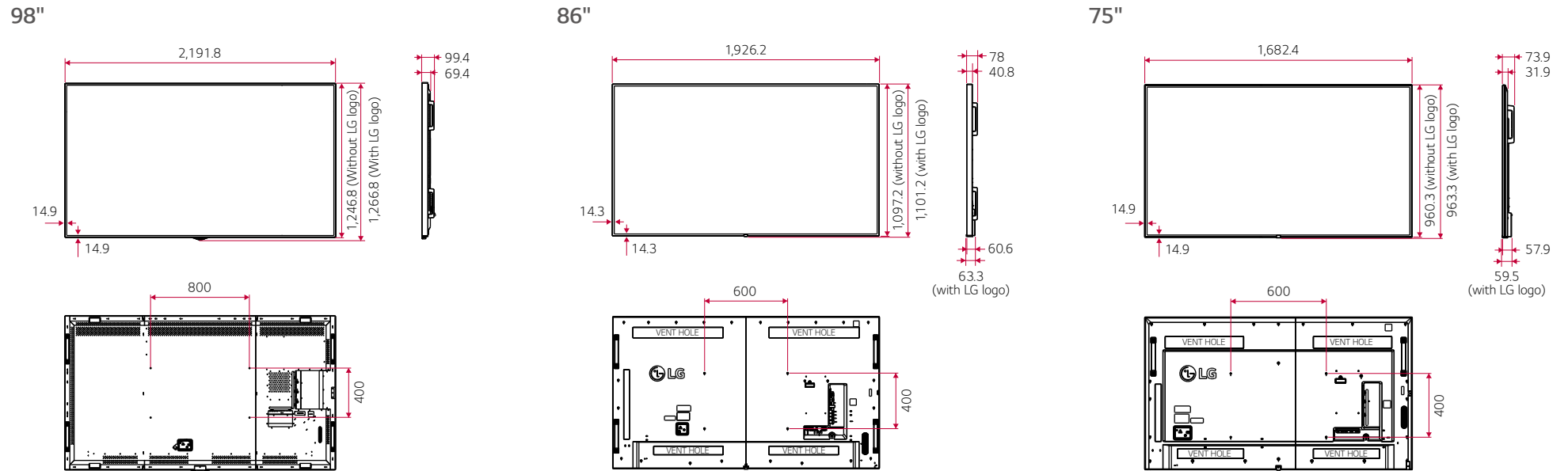

Connectivity

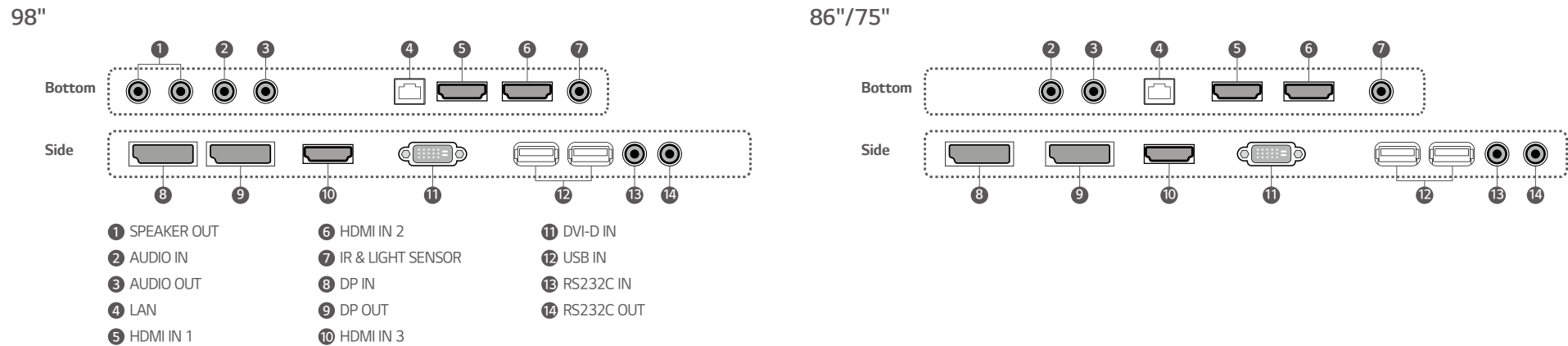

* Dimensions & Jack Panels (Read/Side) may differ from the above image, so please contact LG salesteam to verify before ordering.

Specifications

		98UH5E	86UH5E	75UH5E
PANEL	Screen Size	98"	86"	75"
	Panel Technology	IPS	IPS	IPS
	Aspect Ratio	16:9	16:9	16:9
	Native Resolution	3,840 x 2,160 (UHD)	3,840 x 2,160 (UHD)	3,840 x 2,160 (UHD)
	Brightness (Typ.)	500 cd/m ²	500 cd/m ²	500 cd/m ²
	Contrast Ratio	1,300:1	1,200:1	1,200:1
	Viewing Angle (H x V)	178 x 178	178 x 178	178 x 178
	Response Time	8ms (G to G)	8ms (G to G)	6ms (G to G)
	Surface Treatment (Haze)	Haze 1%	Haze 3%	Haze 3%
	Life Time (Typ.)	50,000 Hrs	50,000 Hrs	50,000 Hrs
Operation Hours	24Hrs	24Hrs	24Hrs	
Orientation	Portrait & Landscape	Portrait & Landscape	Portrait & Landscape	
CONNECTIVITY	Input	HDMI (3), DP, DVI-D, Audio, USB 2.0 (2)		
	Output	DP, Audio (Off/Fixed/Variable), External Speaker (98" Only)		
	External Control	RS232C In/out (4 Pin Phone-Jack), RJ45 (LAN) In, IR In		
MECHANICAL SPECIFICATION	Bezel Color	Black	Black	Black
	Bezel Width	14.9 mm (Even) * Off-Bezel	14.3 mm (Even) * Off-Bezel	14.9 mm (Even) * Off-Bezel
	Monitor Dimension (W x H x D)	2,191.8 x 1,246.8 x 69.4 mm (without Handle)	1,926.2 x 1,097.2 x 60.6 mm (without Handle and Logo)	1,682.4 x 960.3 x 57.9 mm (without Handle and Logo)
	Weight (Head)	88 kg	49 kg	41.5 kg
	Carton Dimensions (W x H x D)	2,342 x 1,386 x 402 mm	2,073 x 1,260 x 292 mm	1,816 x 1,123 x 228 mm
	Packed Weight	123 kg	61.1 kg	49.5 kg
	Handle	Yes	Yes	Yes
	VESA™ Standard Mount Interface	800 x 400 mm	600 x 400 mm	600 x 400 mm
KEY FEATURE	Internal Memory 8GB (System 4GB + Available 3.6GB), Built-in Wi-Fi, Temperature Sensor, Auto Brightness Sensor, Current Sensor, Embedded CMS (USB Auto Playback, Local Contents Scheduling, Group Manager), Image Customization, Failover, Content Sync (RS232C, Local Network), Screen Share, Play via URL, OSD Rotation, Content Rotation, PIP/PBP(4), Tile Mode Setting (Max 15x15), Setting Data Cloning, Firmware Update by Network, SNMP 1.4, ISM Mode, Crestron Connected ^(B1) , Cisco Compatibility ⁽²⁾ , Beacon, HDMI-CEC ⁽³⁾ , SI Server Setting, webRTC			
ENVIRONMENTAL CONDITIONS	Operation Temperature	0°C to 40°C	0°C to 40°C	0°C to 40°C
	Operation Humidity	10% to 80%	10% to 80%	10% to 80%
POWER	Power Supply	100-240V~, 50/60Hz	100-240V~, 50/60Hz	100-240V~, 50/60Hz
	Power Type	Built-In Power	Built-In Power	Built-In Power
	Power Typ. / Max.	420 W / 560 W	215 W / 280 W	180 W / 260 W
	Consumption Smart Energy Saving	294 W	151 W	126 W
SOUND	Speaker	-	Built-in (10W×2)	Built-in (10W×2)
CERTIFICATION	Safety	IEC 60950-1 / EN 60950-1 / UL 60950-1	IEC 60950-1 / EN 60950-1 / UL 60950-1	IEC 60950-1 / EN 60950-1 / UL 60950-1
	EMC	FCC Class "A" / CE / KC	FCC Class "A" / CE / KC	FCC Class "A" / CE / KC
	ErP / Energy Star	N/A / N/A	N/A / N/A	N/A / Yes (Energy Star 7.0)
MEDIA PLAYER COMPATIBILITY	OPS Type Compatible	No	Yes	Yes
EXTERNAL MEDIA PLAYER ATTACHABLE	External Media Player Attachable	Yes	Yes	Yes
SOFTWARE COMPATIBILITY ⁽⁴⁾	Content Management Software	SuperSign CMS	SuperSign CMS	SuperSign CMS
Control and Monitoring Software	SuperSign Control/Control+	SuperSign Control/Control+	SuperSign Control/Control+	
ACCESSORIES	Basic	Remote Controller, Power Cord, QSG, IR/Light Sensor Receiver, DP Cable (1.8M), Regulation Book, Phone to RS232C Gender, EYE-BOLT	Remote Controller, Power Cord, QSG, DP Cable (1.8M), Regulation Book, Phone to RS232C Gender	Remote Controller, Power Cord, QSG, DP Cable (1.8M), Regulation Book, Phone to RS232C Gender
	Optional	Speaker (SP-2200)	Media Player, OPS Kit (KT-OPSA), Wall Mount (LSW640A/B)	Media Player, OPS Kit (KT-OPSA), Wall Mount (LSW640A/B)

1) Network-based control 2) The HDMI connection based 3) Compatibility may differ by equipment 4) Software compatibility may change over time. Please contact LG sales representative for details.



Download
LG C-Display+
Mobile App

Google Play Store

- www.lg.com/b2b
- www.youtube.com/c/LGCommercialDisplay
- www.facebook.com/LGInformationDisplay
- www.linkedin.com/company/LGInformationDisplay

LG may make changes to specifications and product descriptions without notice.
Copyright © 2018 LG Electronics Inc. All rights reserved. "LG Life's Good" is a registered trademark of LG Corp.
The names of products and brands mentioned here may be the trademarks of their respective owners.

